

Operation Instruction For Loop Calibrator

INDEX

| | |
|---|----|
| 1. Safety Information..... | 1 |
| 2. Instrument Panel Layout and Function..... | 2 |
| 3. Replacing the Battery..... | 3 |
| 4. Power-on/off of Calibrator..... | 4 |
| 5. Output from Calibrator..... | 4 |
| 6. Calibrator Measurement..... | 8 |
| 7. Other Features..... | 11 |
| 8. Performance Capabilities..... | 12 |
| 9. Calibration..... | 14 |
| 10. Points for Attention to Use of Operation Instruction..... | 18 |

Operation Instruction For Loop Calibrator

1. Safety Information

To ensure the safety operation, the following signs are used only as specified in this operation instruction.

 **Warning** A warning shows that if the operation does not comply with the following correct instruction it is possible to bring hazards to the user or cause damage to the calibrator in use. The warning also points out how to avoid the accidents.

 **Caution** A caution shows that if the operation does not comply with the following correct instruction, it is possible to cause damage to the calibrator in use. The caution also points out how to avoid maloperation.

 **Note** A note serves as a sign to remind the user that he must understand the correct operation of the calibrator and its characteristics.

To prevent the user and the calibrator from any electric shock and other hazards, it is necessary to observe the following regulation:

 **Warning**

- It is not allowed to operate the calibrator at the working field where there exists flammable gas or explosive gas or vapor. It is very dangerous to operate the calibrator in such a surrounding.
- Never apply more than 30V between any two terminals, or between any terminal and earth ground.

 **Caution**

- Disassembly: No one is allowed to remove the split case (top & bottom) of the calibrator except professionals.
- Cleaning: Periodically wipe the case with a damp cloth and detergent; do not use any corrosive solvents.

Note

- To keep the calibrator in a designed accuracy, it needs warming up 5 minutes before it is put into operation.
- If any user requires a higher accuracy of the calibrator, he or she is requested to make contact with the manufacturer or our product distributors.

2. Instrument Panel Layout and Functions

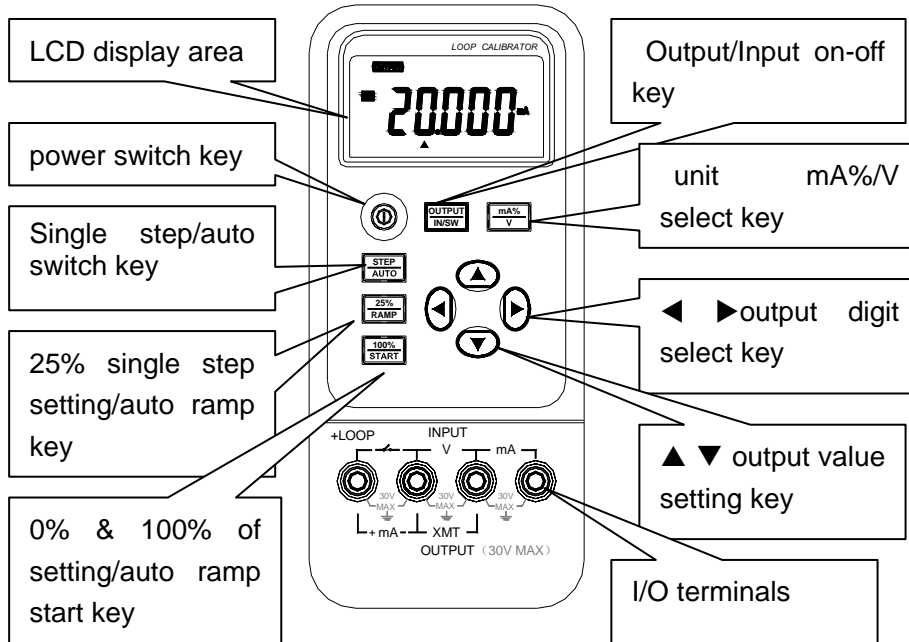

Explanation of LCD Display Area

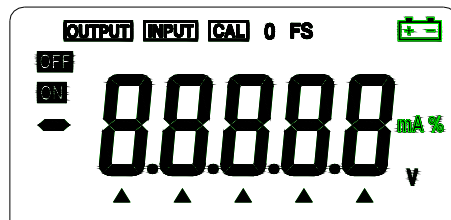

- a) **OUTPUT**: Press the key (OUTPUT / IN / SW) when the

- symbol 'output' appears. It denotes that the calibrator is in a state of output.
- b) **INPUT**: Press the key (**OUTPUT / IN / SW**) when the symbol **INPUT** appears. It denotes that the calibrator is in a state of input.
- c) **CAL**: When the symbol 'CAL' appears, it denotes that the calibrator is in a state of calibration.
- d) **O FS**: When the symbol 'O' or 'FS' appears during the calibration, it denotes that the zero point or the full scale point is being calibrated.
- e) : When this symbol appears, it denotes that the battery is nearly used up and needs replacing. (See subsection 3.1)
- f) **▲**: When this symbol appears, it denotes that the output digits need setting.
- g) **V. mA. %**: These symbols denote the units of both present input and output values.
- h) **ON**, **OFF**: These symbols denote the turn-on or turn-off of any input / output signals.

3.Replacing the Battery

Warning

- The Power supply of the calibrator must be shut down and the test leads need removing prior to replacing the battery.

3.1 When the sign appears in the display, it denotes that the battery is nearly used up and needs replacing in the following steps:

- 1) Turn off the power switch of the calibrator and then remove the test leads.
- 2) Remove the holster from the calibrator. Open the battery cover at the back of the calibrator by releasing the lock in the indicated direction.
- 3) Replace the used-up battery with a new one. Put the battery

cover back and lock it in the indicated direction.

- 4) Put the holster back onto the calibrator.

4. Power-On/Off of Calibrator

4.1 Power key operation

Press the power key to turn on the power supply of the calibrator. Then press it again to hold it in one second and the power will be off. When the power is turned on, the calibrator starts to make self-diagnosis internally and the full screen is in display. After this, appropriate operation should be carried out.

Note

- **Power on:** To ensure the correct operation of the calibrator with power on, it is good practice to turn off the power pausing 5 seconds and then restart the calibrator.

4.2 Automatic power-off

By the shipping time, the calibrator is set in the factory like this: In case there is no operation applied to the calibrator within 10 minutes after power-on, it will cut off the power automatically. However, users can decide whether they want to use the function of the automatic power off or not. The setting can be done by themselves. (See section 7 for reference)

5. Output from Calibrator

The calibrator produces the DC current from its appropriate output terminal set by the user or simulating a transmitter.

Caution

- Do not apply voltage to the output terminal during the operation. If any improper voltage is applied to the output terminal, it will cause damage to the internal circuit.

Output Operation Procedure

| Function Operation | % Operation | Display | Setting Range |
|--------------------|-----------------|-------------------------------|---|
| DCA 20 mA | 20 mA ↓ % | 00.000 mA -025.00 mA % | 00.000 to 22.000 mA -025.00 to 112.50 mA % |

5.1 Current output

- 1) Insert one end of the test leads to the +mA -output jack of the calibrator and connect the other end with the input of the user's instrument as shown in the following diagram:

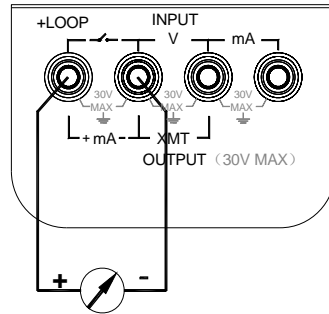

- 2) Press the key (**OUTPUT/IN/SW**) when the **OUTPUT** appears in the display. It denotes that the calibrator is in an output state.
- 3) Press the key (**mA% / V**) to select the

output to be set in mA or %, and then the unit mA or mA% appears, in which 0% denotes 4mA and 100% denotes 20mA.

- 4) Press the key (**◀**) / (**▶**) to select the set digits of the output.
- 5) Press the key (**▲**) / (**▼**) to change the value of the set digits. The value can do carry or number decrement automatically. Hold the pressed key in one second and the numerical value will keep varying.

5.2 25% Step Current Output

- 1) The connection is the same as that of the current output.
- 2) When the key (**OUTPUT/IN/SW**) is pressed, the **OUTPUT** appears in the display, it denotes the calibrator is in an output state.
- 3) Press the key (**25%/RAMP**) and the symbol 'r' will appear.
- 4) Press the key (**mA%/V**) to select the output to be set in mA or %, and then the unit 'mA' or 'mA%' appears.

- 5) Press the key(▲)/(▼)to change the output in a value of 25%, in which 0% denotes 4mA and 100% denotes 20mA.
- 6) Press the key(25%/RAMP)again so as to exit the step current output.

5.3 Current Output Set For Zero Point & Full Scale

- 1) The connection is the same as that of the current output.
- 2) Press the key (OUTPUT/IN/SW) when the symbol 'OUTPUT' appears in the display, denotes that calibrator is in an output state.
- 3) Press the key (100%/START) and the symbols 'r', '0', 'FS' will appear in the display.
- 4) Press the key(▲)to be set to 100% and the current output will be 20mA. Press the key (▼) to be set to 0% and the current output will be 4mA.
- 5) Press the key (100%/START) again so as to exit the current output of 0% and 100%.

5.4 Auto-ramp

- 1) The electric connection is the same as that of the current output.
- 2) When the key (OUTPUT/IN/SW) is pressed, the 'OUTPUT' appears in the display. It denotes the calibrator in an output state.
- 3) When the key (STEP/AUTO) is pressed, the symbols 'OUTPUT', 'OFF', 'L' along with '4mA'appear in the display. If so, it denotes that the calibrator is getting into the mode of RAMP.
- 4) Press the key (25%/RAMP) again so as to change the type of the output ramp, which finds itself in the upper right of the display. The type appears with 'L', 'H', 'r' in proper order. These symbols denote a low speed ramp , a high speed ramp and a auto-stair step ramp respectively. The former is set to a cycle up to 60S and the latter is up to 30S, while the auto-stair step ramp pauses 5 seconds at each step.

- 5) Press the key (**100%/START**) to start the output of the set waveform when the symbol **ON** appears. Now press the key (**100%/START**) again and the output will pause on a current value and the symbol **OFF** will appear. Then press the same key again and the output will continue to do the set steps from the pause value. When the symbol **OFF** appears, press any one of the keys (**◀**) , (**▶**) , (**▲**) , (**▼**) so as to bring the output back to the 0%. Then the value of 4mA appears in the display.

5.5 Simulating Transmitter Output(XMT)

- 1) Insert one end of the test lead to the 'XMT' output jack of the calibrator and connect the other end with the input terminal of the user's instrument as shown in the following diagram:

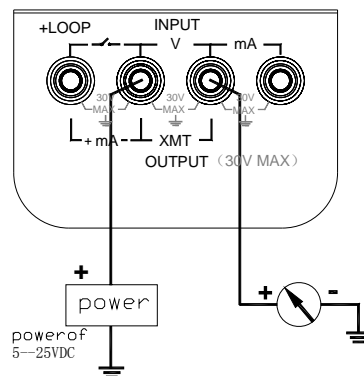

- 2) The key-operation is the same as that of the current output in subsection 5.1.

Note

- Range of power supply: 5 to 25VDC.
- During the operation of the current output, try your best to use the external 24VDC power supply in a mode of connecting a transmitter, thus being able to prolong the working life of the battery.

6. Calibrator Measurement

Warning

- During the operation, never apply more than 30V between any two terminals, or between any terminal and earth ground. Any voltage more than 30V will not only do damage to the calibrator, but also lead to possible personal injury.

Caution

- During the operation, do not apply a voltage or current exceeding the measuring range to the input terminal, which will cause possible damage to the calibrator.
- During the operation, cut off the power supply of the instrument to be tested before connecting the calibrator to the said instrument. The electric connection with such an instrument without cutting off its power supply will cause possible damage to the calibrator.

Input operation procedure

| Function Operation | % Operation | Display | Measuring Range |
|--------------------|-------------|--------------|-----------------------|
| DCA 20 mA | 20 mA | 00.000 mA | -1.000 to 22.000 mA |
| ↓ | ↓ | | |
| | % | -025.00 mA % | -031.25 to 112.50 mA% |
| DCV 28V | | 0.000 V | -0.2000 to 28.000V |

6.1 Measuring DC Current

- 1) Insert one end of the test lead into the mA jack of the calibrator input terminal and connect the other end to the output of the user's instrument as shown in the following diagram:

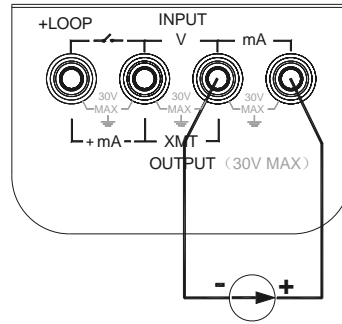

- 2) When the key (**OUTPUT/ IN/SW**) is pressed, the symbol **INPUT** appears in the display. It denotes that the calibrator is in an input state.
- 3) Press the key (**mA%/V**) to select the input to be set in mA or %. Then the unit 'mA' or 'mA%' appears, in which the value of 0% denotes 4mA and the value of 100% denotes 20mA.
- 4) The calibrator starts measurements, and then the symbol **ON** appears in the display followed by the result of measurements.

The refreshing rate of displaying the measurement is about twice per second. If the measured value exceeds the measuring range, the display will indicate the symbol '-OL-'.

6.2 Measuring DC Voltage

- 1) Insert one end of the test lead into the V input jack of the calibrator and connect the other end with the output of the user's instrument as show in the following diagram:

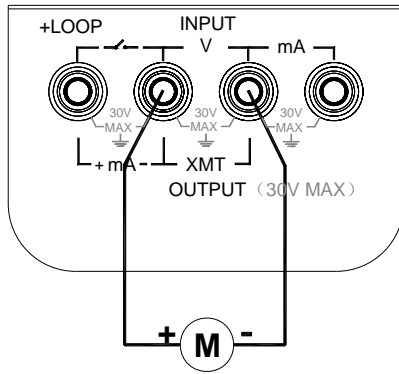

2) When the key (**OUTPUT / IN/SW**) is pressed, the display indicates the symbol **INPUT**. It denotes that the calibrator is in an input state.

3) Press the key (**mA%/V**) to select the V function when the unit 'V' appears in the display.

4) The calibrator starts measurements, and then the display indicates the symbol **ON**

followed by the result of measurements.

5) The refreshing rate of the measurement display is about twice per second. If the measured value exceeds the measuring range, the display will indicate the symbol '-OL-' (overload).

6.3 Providing 24V Power Supply For Measuring Loop Current

1) Insert the test lead into the +LOOP & mA input jacks of the calibrator as shown in the following diagram:

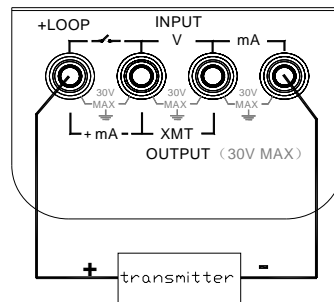

2) The key operation is the same as that of measuring the DC current in subsection 6.1

6.4 Measuring Switching contact Status

- 1) Insert one end of the test lead into the switching contact measuring jack of the calibrator and connect the other end to the switching contact of the user's instrument as shown in the following diagram:

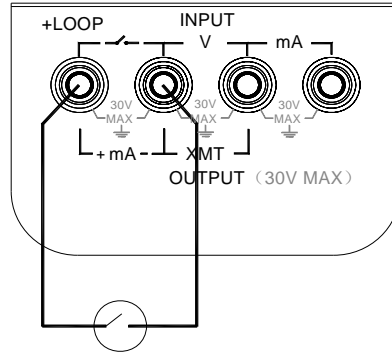

- 2) When the key (**OUTPUT / IN/ SW**) is pressed, the display indicates the symbol **INPUT** followed by the word 'CLOSE' or 'OPEN' according to the measured switching contact status.

When the switching resistance exceeds $15K \Omega$, the contact is regarded as an off state.

7. Other Features

The following operation makes it possible for the calibrator to change its automatic power-off function.

- 1) Cut off the power supply of the calibrator.
- 2) Press both the keys (**POWER**) and (**mA%/V**) simultaneously so that the calibrator can get into a maintenance state. The display indicates the symbol 'AP-XX'.
- 3) Press the key (**▼**) when the symbol 'AP-OF' appears, which denotes that there is no automatic power-off function available for use with the calibrator. When the symbol 'AP-ON' appears in the display, the calibrator recovers its automatic power-off function.

- 4) Cut off the power supply again to exit the state of the maintenance.

8. Performance Capabilities

Output Performance Capabilities(applicable to temperature range form 18°C to 28°C,within one year after calibration)

| Output | Measuring Range | Output Range | Resolution | Accuracy | Remark |
|--------------------------------------|-----------------|--------------------|------------|--|-------------------------------------|
| Current | 20mA | 0.000 to 22.000mA | 0.001mA | $\pm 0.05\%$ of set value $\pm 4 \mu A$ | Max.1K Ω at 20mA see Note 1. |
| Simu. transmitter. (absorp. current) | -20mA | 0.000 to -22.000mA | 0.001mA | $\pm 0.05\%$ of set value $\pm 4 \mu A$ | Max.1K Ω at 20mA see Note 2. |
| Loop power | 24V | | | $\pm 10\%$ | Max. output current up to 25mA |

Input Performance Capabilities(applicable to temperature range form 18°C to 28,within one year after calibration)

| Input | Range | Input Range | Resolution | Accuracy | Remark |
|--------------|-------|--------------------|------------|--|------------------------------|
| Voltage | 28V | -0.200 to 28.000V | 1mV | $\pm 0.02\%$ of reading $\pm 2mV$ | input resistance 2M Ω |
| Current | 20mA | -1.000 to 22.000mA | 0.001mA | $\pm 0.02\%$ of reading $\pm 4 \mu A$ | input resistance 10 Ω |
| Loop current | 20mA | 0.000 to 22.000mA | 0.001mA | $\pm 0.02\%$ of reading $\pm 4 \mu A$ | providing 24V loop power |

- Notes: 1. When the battery voltage exceeds 6.8V, the max. load is 1K Ω at 20mA. When its voltage lies between 5.8V and 6.8V, the max. load is 700 Ω at 20mA.
2. Power supply range: 5 to 25VDC.
3. Temperature coefficient: $\pm 0.005\%$ of range per $^{\circ}\text{C}$ for the temperature ranges 5°C to 18°C and 28°C to 40°C .

General Specifications

- Power supply: 9V battery(ANSI/NEDA 1604A or IEC 6LR619V alkaline)
- Battery life: about 20 hours under the condition of 10mA
- Max. permitted voltage: 30V(between any two terminals or between any terminal and earth ground)
- Operating temperature : 0°C to 50°C
- Operating relative humidity: $\leq 80\%$ RH
- Storage temperature : $\leq -10^{\circ}\text{C}$ to 55°C
- Relative humidity for storage: $\leq 90\%$ RH
- Size: 200 \times 100 \times 40mm(with holster)
- Weight: 550g(with holster)
- Accessories: operation instruction, a set of CF-36 industrial test lead (with alligator clips attached to probes)
- Option: AC power-supply adapter(VCPS), industrial test lead(CF-31-A with probe clips)
- Safety: certified as compliant to IEC1010 provisions(Safety standard issued by International Electrotechnical Commission)

9. Calibration

Note

- In order to keep the designed accuracy of the calibrator, it is recommendable to calibrate your calibrator once a year. The following example shows the use of recommended standard equipment to perform the calibration.

! Caution

- During the operation, never apply more than the max. permitted voltage to the input of the calibrator, otherwise the overvoltage will lead to possible damage to the input section.
- During the operation, avoid short circuit and never apply more than the max. permitted voltage to the output of the calibrator or to a co-working standard device, otherwise any maloperation will cause possible damage to their internal circuits.

9.1 Selecting Standard Equipment

Calibration of Output Characteristics

| Calib. Item | Standard Equipment | Input Range | Accuracy | Recommend |
|-------------|--------------------|-------------|------------------------------------|------------------------------|
| DCA 20mA | Digital meter | Max.22mA | $\pm(50\text{ppm}+0.4\mu\text{A})$ | 1280(FLUKE) or equivalent |

Calibration of Input Characteristics

| Calib.Item | Standard Equipment | Output Range | Accuracy | Recommend |
|------------|--------------------|--------------|-------------------------------------|------------------------------|
| DCA 20mA | Standard source | 20mA | $\pm(100\text{ppm}+0.2\mu\text{A})$ | 5520(FLUKE) or equivalent |
| DCV 28V | Standard source | 30V | $\pm(12\text{ppm}+15\mu\text{V})$ | 5520(FLUKE) or equivalent |

9.2 Ambient Condition for Calibration

Ambient temperature: $23^{\circ}\text{C} \pm 1^{\circ}\text{C}$

Relative humidity: 45 to 75% RH

Warming up:

- Standard equipment must be warmed up to the given time.
- Do not connect the calibrator to the power supply until it has been exposed to the calibrating ambient condition for 24 hours. Then set the calibrator to a state of non-automatic shutdown followed by warming up to one hour.

Note

- Power supply for calibrator: During the calibration, it is good practice to replace the old battery with a new alkaline one.

9.3 Operating Output Calibration

Operating calibration in order of items and calibration points listed in the following table:

| Item No. | Output Range | Calibration Point |
|----------|--------------|-------------------|
| 1 | 20.000mA | 0 |
| | | FS |
| | | 0 FS |

9.3.1 20mA Range Calibration

- 1) The calibration wiring diagram is shown as follows:

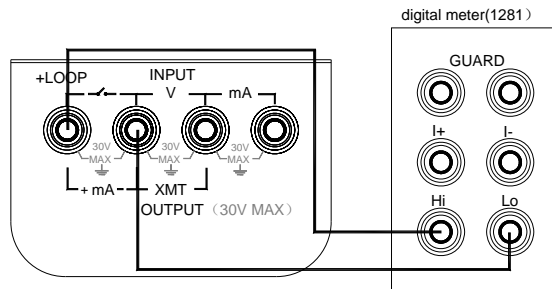

- 2) Press the keys (**POWER**), (**OUTPUT / INPUT/SW**) and (**mA%/V**) simultaneously to enter the calibrator in a state

of 20mA output calibration, and then the symbols 'OUTPUT', 'CAL 0', 'ON' and 'mA' appear in the display.

- 3) Set the digital meter to an appropriate range.
- 4) With the output stabilized, operate the keys (◀) / (▶) and (▲) / (▼) to adjust the calibrator to a value in identity with the reading of the digital meter.
- 5) Now press the key (100%/START) and the display will flash, denoting that the calibrated point has been stored.
- 6) Press the key (STEP/AUTO) and the display will indicate 'CAL FS'. With the output stabilized, repeat the operation of steps 4 and 5.
- 7) Press the key (STEP/AUTO) and the display will indicate 'CAL 0 FS'. With the output stabilized, repeat the operation of steps 4 & 5.

Note

- **Calibration storage:** When the key (100%/START) is pressed to store the calibrated value, there is no flash in the display, denoting the storing of calibration is invalid.

9.4 Operating Input Calibration

Operating calibration in order of items and calibration points in the following table:

| Item No. | Input Range | Calibration Point |
|----------|-------------|-------------------------------|
| 1 | 20.000mA | 0 : 00.000mA FS : 19.000mA |
| 2 | 28.0000V | 0 : 00.000V FS : 19.000V |

9.4.1 20mA Range Calibration

- 1) The calibrating wiring is shown in the following diagram:

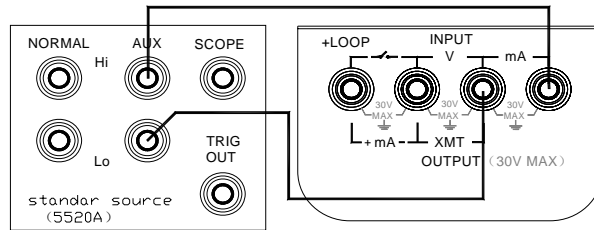

- 2) Press the key (**OUTPUT / IN/SW**) to enter the calibrator in a state of 20mA input calibration. Then the display indicates 'INPUT', 'CAL 0', 'ON' and '00.000mA'.
- 3) Set the standard source to an appropriate range.
- 4) Set the standard source output to the indication of the calibrator. Then press the key (**100%/START**) to start flashing in the display, denoting that the calibrated point has been stored.
- 5) Press the key (**STEP/AUTO**) to display 'CAL FS'. With the output stabilized, repeat the operation of step 4. To exit, turn off the power supply.

9.4.2 28V Range Calibration

- 1) Calibration wiring is shown in the following diagram:

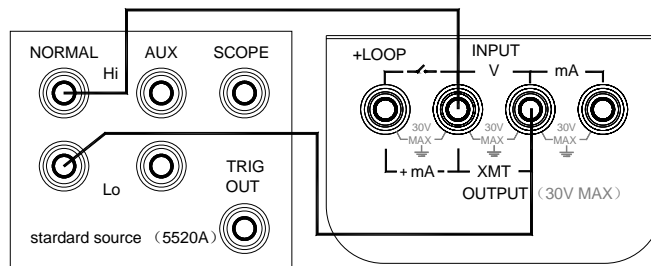

- 2) Press the key (**OUTPUT/IN/SW**) to enter the calibrator in a state of 28V input calibration, and then display indicates the symbols **INPUT** , **CAL 0**, **ON** and '00.000V'.
- 3) Set the standard source to an appropriate range.
- 4) Set the output of the standard source to the indication of the calibration. With the output stabilized, press the key (**100%/START**) to start flashing the display, denoting that the calibrated point has been stored.
- 5) Press the key (**STEP/AOUT**) to display **CAL FS** . With the output stabilized, repeat the operation of step 4.

10. Points for Attention to Use of Operation

Instruction

- The present operation instruction is subject to change without notice.
- The content of the operation instruction is regarded as correct. Whenever any user finds its mistakes, omissions, etc., he is requested to contact the manufacturer.
- The present manufacturer is not liable for any accident and hazard arising from any maloperation.
- The functions described in this operation instruction should not be used as grounds to apply this product to a particular purpose.